

THWAITES 10 TONNE DUMPER

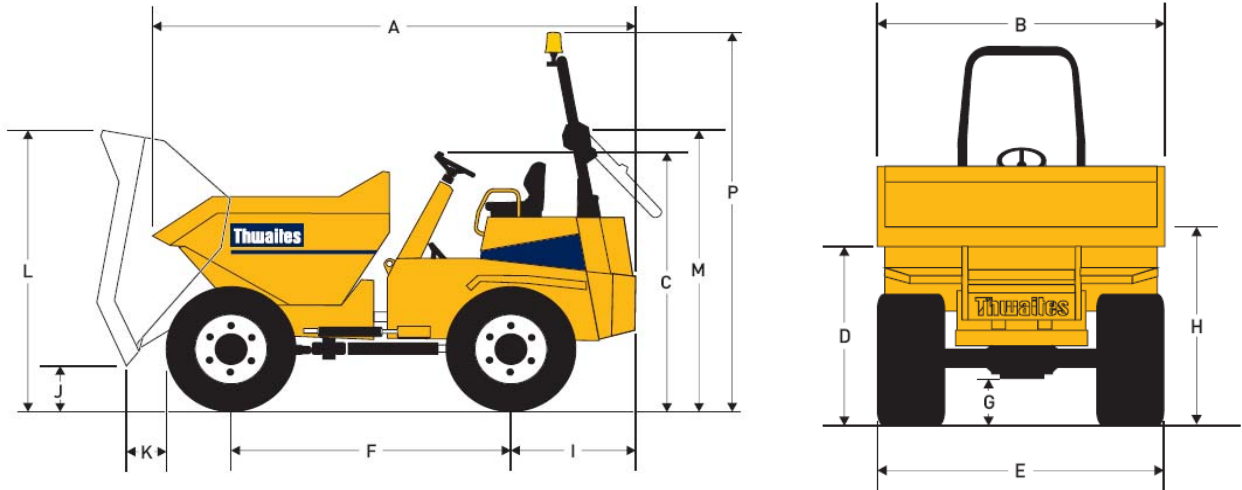

DIMENSIONS	
mm	
A	4650
B	2485
C	2540
D	1740
E	2440
F	2615
G	447
H	2135
I	1220
J	436
K	768
L	2860
M	2630
P	3415

CAPACITIES	
Max.safe load	10000 kg
Heaped	4700 litres
Struck	4110 litres
Water	2350 litres
Unladen Weight	4710 kg
SPEEDS - FORWARD & REVERSE	
1	3.1 mph
2	5.5 mph
3	10.5 mph
4	17.8 mph
TYRE PRESSURES	
FRONT	3.2 Bar 46 PSI
REAR	1.6 Bar 24 PSI
NOISE LEVELS	
Operators ear	84LpA
Airborne sound power	103 LwA

KEY FEATURES

- ◆ Thwaites Kinglink chassis provides superior stability and traction for rough terrain.
- ◆ Hydraulic priority power steering.
- ◆ Hydraulically operated skip with 6mm steel base plate and reinforced sides to minimise skip damage.
- ◆ Front tip.
- ◆ 4 x 4 drive.
- ◆ Adjustable suspension seat, accessible from both sides.
- ◆ Super bright warning lights for all critical functions.
- ◆ Hinged folding R.O.P.S. frame is fitted as standard.



CALL **VHS** PLANT HIRE on 0121 360 4161

